

Project _____

Dealer _____

Item # _____ Quantity _____

PRO-LINE

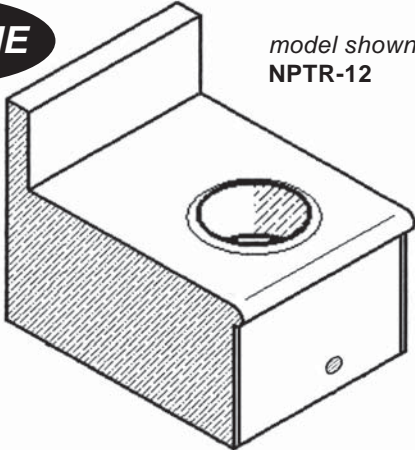

model shown:
NPTR-12

PRO-LINE SERIES 20" DEEP

model # (for different sizes call)	length
<input type="checkbox"/> NPTR-12.....	12"
<input type="checkbox"/> NPTR-13.....	13"
<input type="checkbox"/> NPTR-15.....	15"

CUSTOM SERIES 24" DEEP

model # (for different sizes call)	length
<input type="checkbox"/> NCTR-12.....	12"
<input type="checkbox"/> NCTR-13.....	13"
<input type="checkbox"/> NCTR-15.....	15"

STANDARD FEATURES

- 18 gauge #304 stainless
- Bullnose front design
- Seamless top
- Sound insulation undercoating
- 6" High back splash

CUSTOM

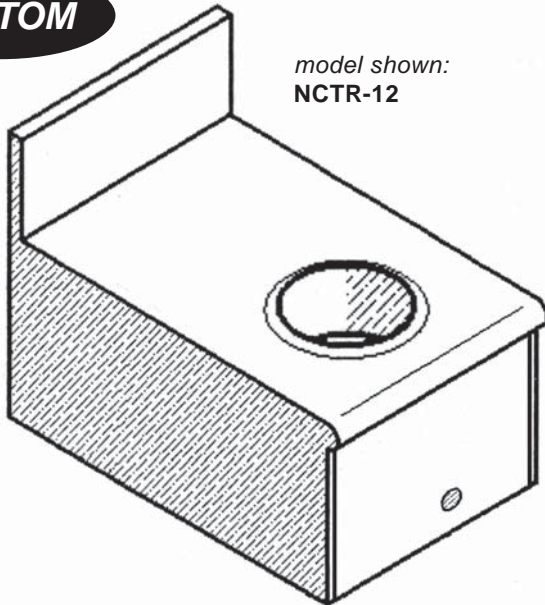

model shown:
NCTR-12

OPTIONAL FEATURES

model #	description
<input type="checkbox"/> CB.....	cabinet base
<input type="checkbox"/> APR (removable).....	hinged apron frnt pnl
<input type="checkbox"/> M.....	modified size
<input type="checkbox"/> SP__ (4", 8", 10", 12").....	high splash upg.
<input type="checkbox"/> AS (instead of galv. lower back).....	all stainless st. upg.
<input type="checkbox"/> SSF__(L-left, R-right, B-both).....	side splash add on

*see options section for more details



PRO-LINE

model shown:
NPTR-*X

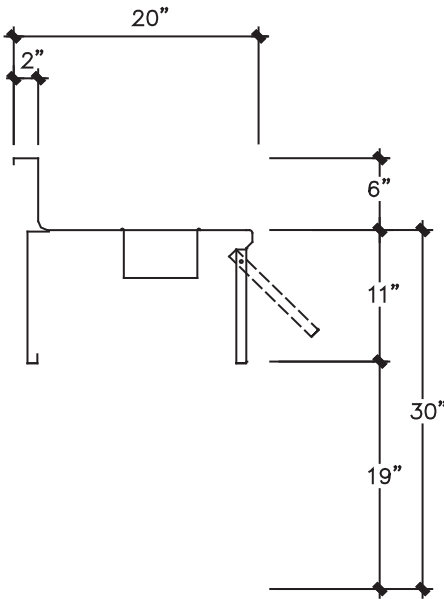
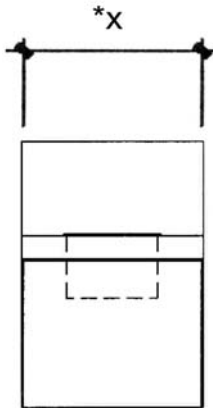
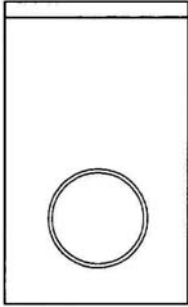

CUSTOM

model shown:
NCTR-*X

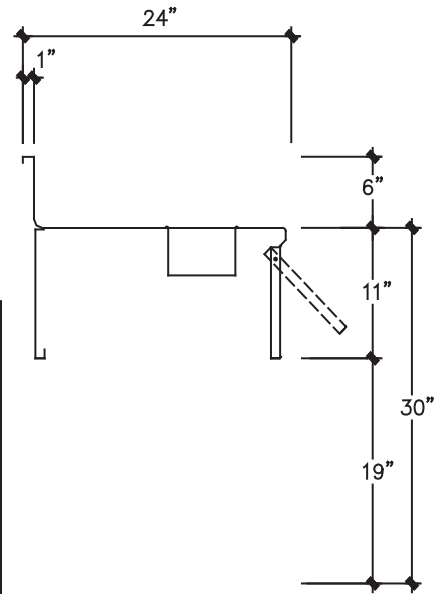
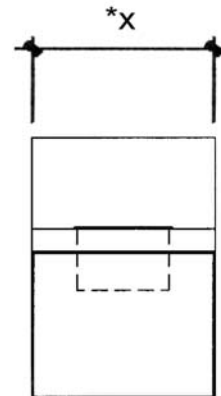
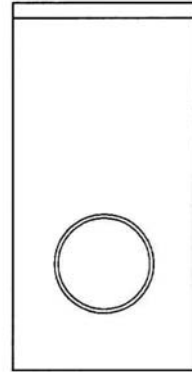

TECHNICAL DATA

model #	length *X	shipping weight (lbs.)
NPTR-12	12"	25
NPTR-15	15"	30
NCTR-12	12"	30
NCTR-15	15"	35

SECTION (PRO-LINE)

SECTION (CUSTOM)