

Project \_\_\_\_\_

Dealer \_\_\_\_\_

Item # \_\_\_\_\_ Quantity \_\_\_\_\_

## PRO-LINE

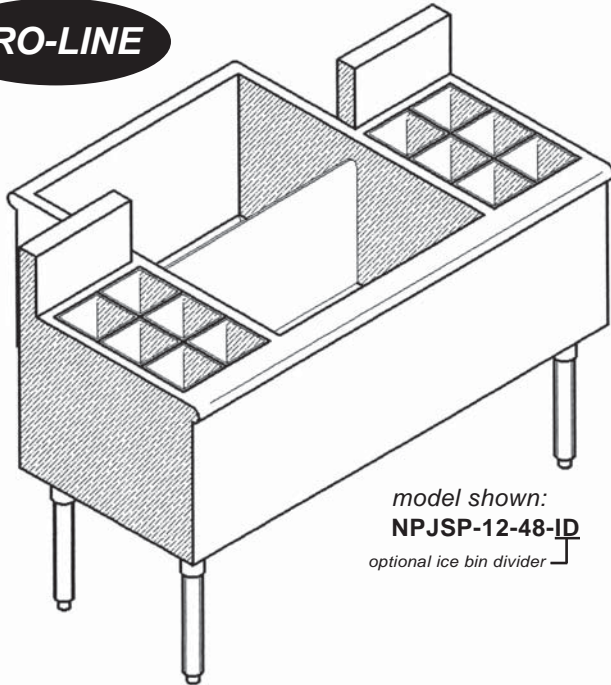

model shown:  
**NPJSP-12-48-ID**  
optional ice bin divider

## PRO-LINE SERIES 20" DEEP

model # (for different sizes call)	length
<input type="checkbox"/> NPJSP-0-24.....	24"
<input type="checkbox"/> NPJSP-3-30.....	30"
<input type="checkbox"/> NPJSP-6-36.....	36"
<input type="checkbox"/> NPJSP-9-42.....	42"
<input type="checkbox"/> NPJSP-12-48.....	48"

## CUSTOM SERIES 24" DEEP

model # (for different sizes call)	length
<input type="checkbox"/> NCJSP-0-24.....	24"
<input type="checkbox"/> NCJSP-4-30.....	30"
<input type="checkbox"/> NCJSP-8-36.....	36"
<input type="checkbox"/> NCJSP-12-42.....	42"
<input type="checkbox"/> NCJSP-16-48.....	48"

## STANDARD FEATURES

- 18 gauge #304 stainless
- Heavy duty stainless gussets, legs, adj. feet & support channels
- Bullnose front design
- Sound insulation undercoating
- Pass-thru bar die design
- Foam insulated ice bins
- Stainless steel bottle well cans
- Bottle wells
- 6" High back splash
- 10" Inside deep ice bin

## OPTIONAL FEATURES

model #	description
<input type="checkbox"/> CT.....	condiment tray
<input type="checkbox"/> CB.....	cabinet base
<input type="checkbox"/> APR (removable).....	hinged apron frnt pnl
<input type="checkbox"/> DR (used w/ -CB).....	doors
<input type="checkbox"/> SR.....	speed rail
<input type="checkbox"/> DSR.....	double speed rail
<input type="checkbox"/> FB.....	false bottom
<input type="checkbox"/> CP__(8, 10 or 12 circuit).....	cold plate add on
<input type="checkbox"/> EDP (incr.).....	12" inside deep bin
<input type="checkbox"/> BC.....	beer chase
<input type="checkbox"/> SN.....	soda notch
<input type="checkbox"/> RC.....	removable cover
<input type="checkbox"/> ID.....	ice bin divider
<input type="checkbox"/> SP__(4", 8", 10", 12").....	high splash upg.
<input type="checkbox"/> AS (instead of galv. lower back)....	all stainless st. upg.
<input type="checkbox"/> SSF__(L-left, R-right, B-both).....	side splash add on
<input type="checkbox"/> M.....	modified size

\*see options section for more details

## CUSTOM

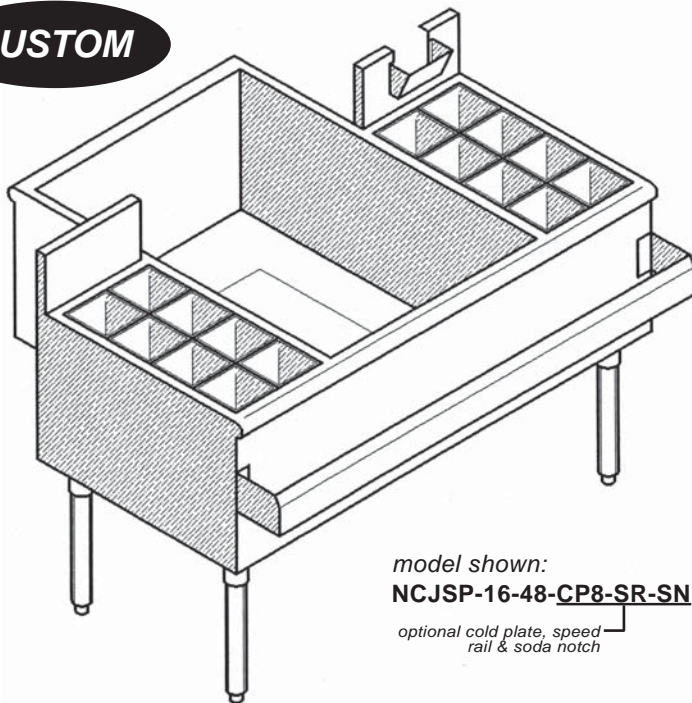

model shown:  
**NCJSP-16-48-CP8-SR-SN**  
optional cold plate, speed rail & soda notch

## SPECIFICATIONS

### PLUMBING:

- 1" drain connection (w/o cold plates)
- 1/2" drain connection w/cold plate (8-circuit)
- 3/4" drain connection w/cold plate (10 or 12 circuit)



## PRO-LINE

model shown:  
NPJSP-0-24

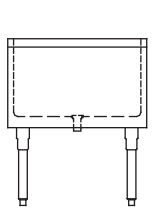
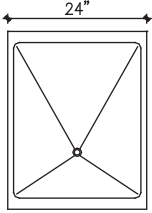

model shown:  
NPJSP-3-30

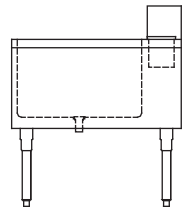
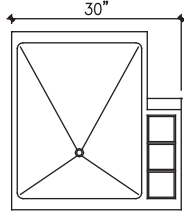

model shown:  
NPJSP-6-36

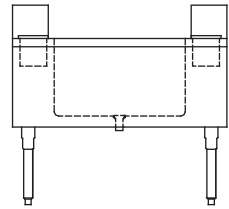
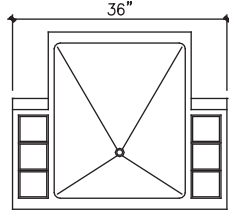

model shown:  
NPJSP-9-42

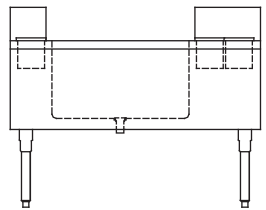
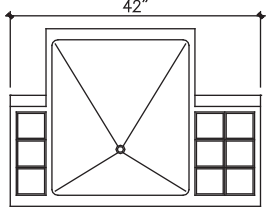

model shown:  
NPJSP-12-48

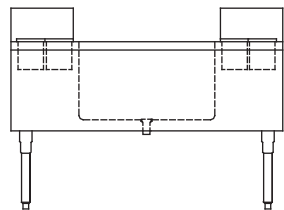
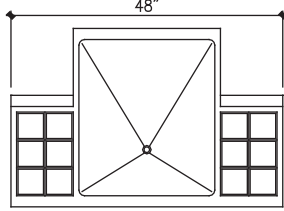

## CUSTOM

model shown:  
NCJSP-0-24

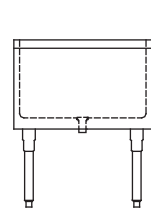
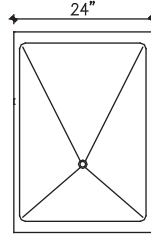

model shown:  
NCJSP-4-30

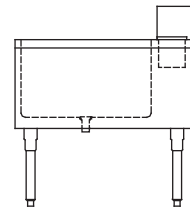
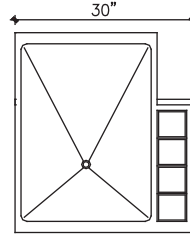

model shown:  
NCJSP-8-36

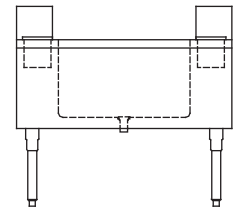
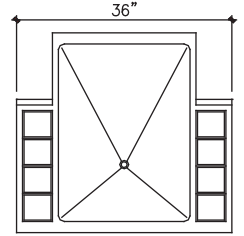

model shown:  
NCJSP-12-42

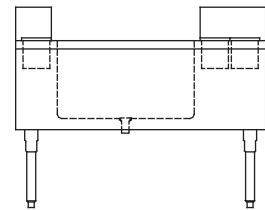
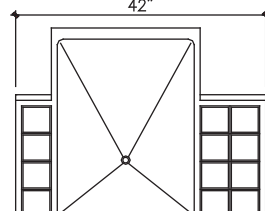

model shown:  
NCJSP-16-48

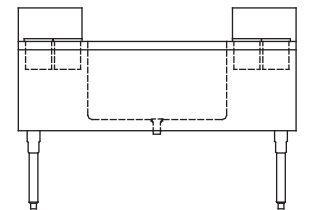
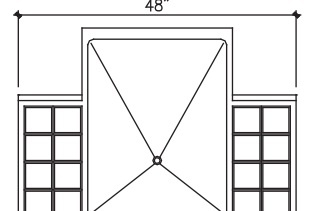

### TECHNICAL DATA

model #	length	bottle wells	ice capacity (lbs.)	shipping weight (lbs.)
NPJSP-0-24	24"	0	160	90
NPJSP-3-30	30"	3	160	100
NPJSP-6-36	36"	6	160	110
NPJSP-9-42	42"	9	160	120
NPJSP-12-48	48"	12	160	130
NCJSP-0-24	24"	0	180	100
NCJSP-4-30	30"	4	180	110
NCJSP-8-36	36"	8	180	120
NCJSP-12-42	42"	12	180	130
NCJSP-16-48	48"	16	180	140

## SECTION (PRO-LINE)

NATIONAL BAR SYSTEMS

Phone: (714) 848-1688

## SECTION (CUSTOM)

16571 Burke Lane Huntington Beach, CA 92647

Fax: (714) 848-2788

Website: [www.nbsmf.com](http://www.nbsmf.com)